



Acme Sanitary Ware Co Ltd

Acme Building, 22-28 Nanking Street, Kowloon, Hong Kong
Tel: 2388 7171 Fax: 2710 8012
E-mail: acme@acmesanitary.com.hk
Website: www.acmesanitaryware.com.hk



Pure Freude
an Wasser

PROJECT		REF		REV	ITEM CODE	
LOCATION		DATE			PAGE	

SANITARY WARE SPECIFICATION SHEET

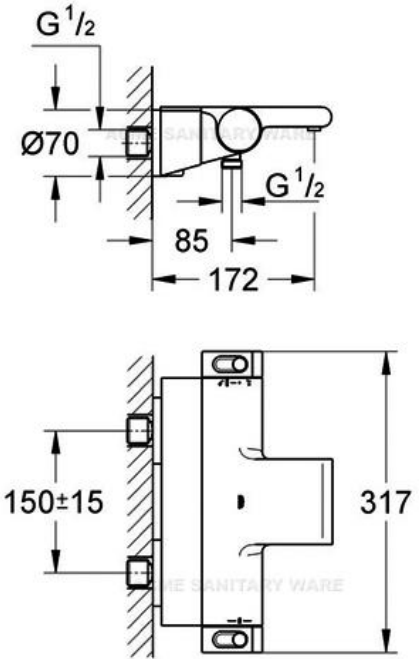
<p>Item Descriptions</p> <p>Dimensions</p> <p>Model</p> <p>Finish</p> <p>Manufacturer</p> <p>Supplier</p> <p>Contact Tel/Fax</p> <p>E-mail</p> <p>Website</p>	<p>GROHE (Germany) "Grohtherm 2000" Thermostatic bath & shower mixer</p> <p>L317 x W172 x H70 mm</p> <p>34464001</p> <p>Chrome Plated</p> <p>GROHE Limited</p> <p>Acme Sanitary Ware Co. Ltd Mr. Eric Wong/ Mr. Don Yuen</p> <p>(852) 2388-7171 / (852) 2710-8012 acme@acmesanitary.com.hk www.acmesanitary.com.hk</p>	<p>Illustration/ Drawing</p>  
<p>wall mounted</p> <p>100% GROHE CoolTouch consisting of safety housing + S-unions with CoolTouch escutcheons</p> <p>GROHE StarLight chrome finish</p> <p>GROHE Aqua Paddle ergonomically shaped handles</p> <p>GROHE SafeStop at 38°C</p> <p>GROHE SafeStop Plus optional temperature limiter at 43°C included</p> <p>GROHE TurboStat compact cartridge with wax thermoelement</p> <p>integrated mixed water shut off</p> <p>GROHE AquaDimmer Eco with multiple function: integrated GROHE EcoButton (economy button with economy stop for shower)</p> <p>shower bottom outlet 1/2"</p> <p>GROHE XL Waterfall flow straightener</p> <p>built-in non return valves / dirt strainers</p> <p>protected against backflow</p> <p>covered S-unions, CoolTouch escutcheons with wall sealing</p> <p>optional upgrade: GROHE EasyReach shower tray (18 608 001)</p> <p>GROHE EcoJoy technology for less water and perfect flow</p>	<p>metal tray</p> <p>removable for easy cleaning</p> <p>GROHE StarLight chrome finish suitable for Grohtherm 2000</p> <p>- exposed thermostatic shower mixer with centre distance 150 mm</p> <p>- exposed thermostatic bath mixer with centre distance 150 mm</p>	

Note: 34464001 = 34174001 (Shower mixer) + 18608001 (Shower tray)



* All information of the above is for the reference only. No prior notice is made if any changes.



PROJECT		REF		REV	ITEM CODE	
LOCATION		DATE			PAGE	

SANITARY WARE SPECIFICATION SHEET

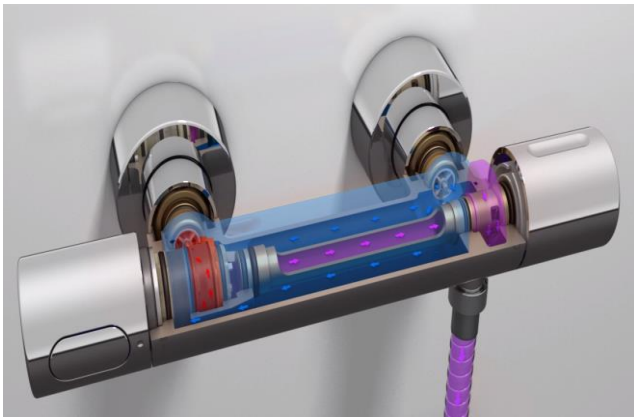

met GROHE CoolTouch®

zonder CoolTouch® technologie

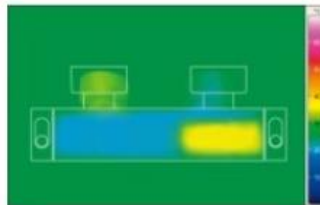
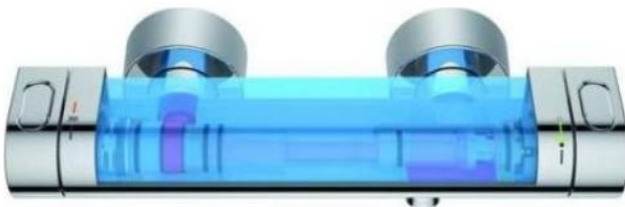

GROHE CoolTouch – never too hot to handle

Thanks to the GROHE CoolTouch technology, the temperature of the tap body will never exceed your shower temperature. Engineered with an integrated cooling channel separating the hot water supply from the outer surface of your thermostat, it is always safe for you to handle. This feature is especially important to protect children from scalding on hot tap surfaces, making your bathroom safely enjoyable for the whole family.

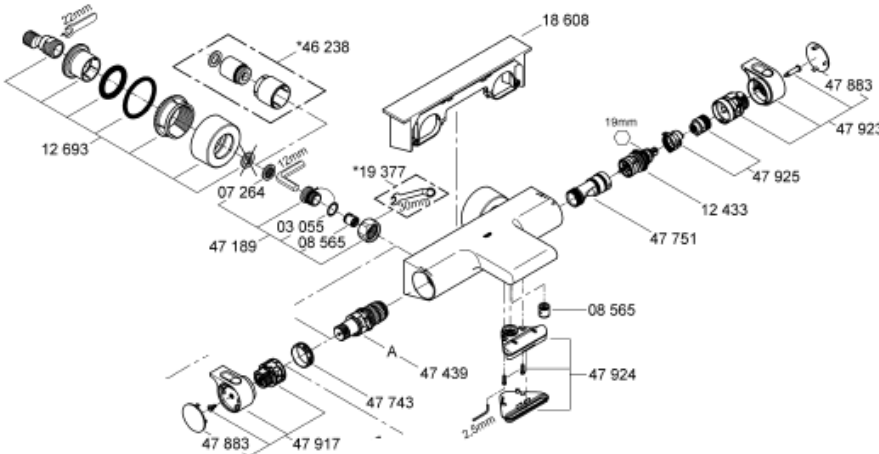

Note:

* All information of the above is for the reference only. No prior notice is made if any changes.



打道七號入境事務大樓 48 樓
48/F, Immigration Tower, 7 Gloucester Road, Wan Chai, Hong Kong

本署檔號 : (4) in WSD 3321/2021 T/J(779/2021)
Our ref.
來函檔號 :
Your ref.

電話 :
Tel.
傳真 : 2824 0578
Fax.

14 July 2021

Approval of "GROHE" Thermostatic Mixer (General Acceptance No. C20210758)

Your letters ref. WRC/2549 and C-WSD/0783 dated 17 May 2021 and 21 June 2021 respectively refer.

Having considered the test report ref. J26378r1 issued on 15 June 2021 by Nutek Systems (HK) Ltd., this Authority accepts that the fitting described below complies with, and its use when correctly installed does not contravene, the Waterworks Ordinance and Regulations.

Name of Manufacturer: Grohe AG
Country of Origin: Germany
Brand: Grohe
Details of Fitting: 1/2" Thermostatic bath and shower mixer
Model: 34464XX1
(where "XX" denote the code of colour)
Body Markings: 
Expiry Date: 7 April 2026



This Authority hereby permits the use of the above fitting in fresh water plumbing systems subject to full adherence to Waterworks installation requirements. In particular, you are required to draw your customers' attention to the following requirement-

"The cold water supply to the fitting shall be drawn from the same source that supplies the hot water apparatus so as to provide a balanced pressure and to obviate the risk of scalding in the event of a restriction or failure in the water supply." AND

"The shower head or handspray should not be placed in submerged conditions and should be securely fixed to the original position after use."

A condition of this acceptance is that the fitting to be installed shall be replicas of the sample as certified by the testing agent mentioned above and without modifications. This acceptance may be withdrawn at any time if the standard of the fitting installed fails to meet that of the approved sample or if the fitting is found to be unsuitable for use in fresh water plumbing systems.

This acceptance is only applicable to the main body of the fitting, unless otherwise specified.

For the use of the fitting in any project, the General Acceptance Number of this letter must be quoted as a means of identification of acceptance of the fitting by this Authority.

Should you have any enquiries, please contact our Engineer Mr. Terry KUNG at tel. no. 3583 4086.

Yours faithfully,



(Roger WONG)
for Director of Water Supplies

Encl.

c.c. WSD 3321/1/82] - without catalogue
 ME/MC] - with soft copy only